

PROVENCE

QWBC

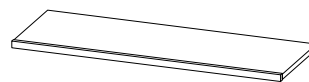

x5

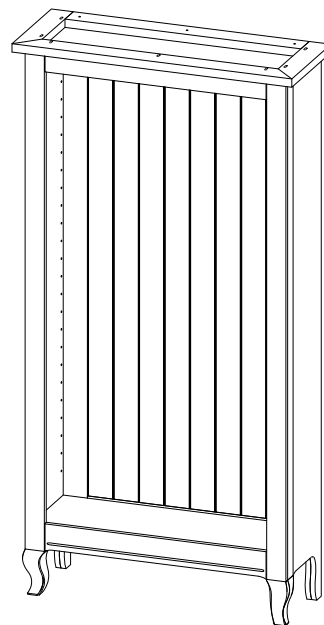
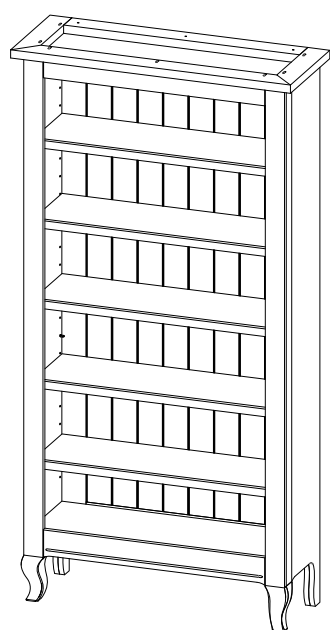
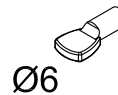

Ø6

x20



M4x20

x4



x2

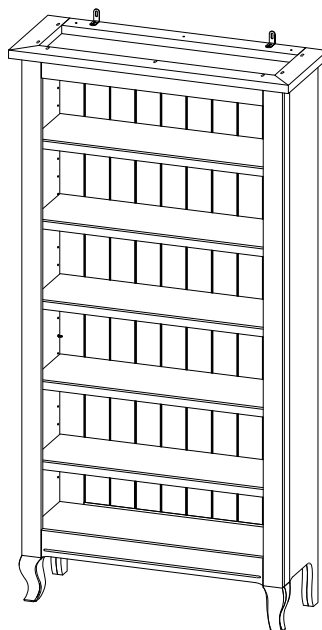
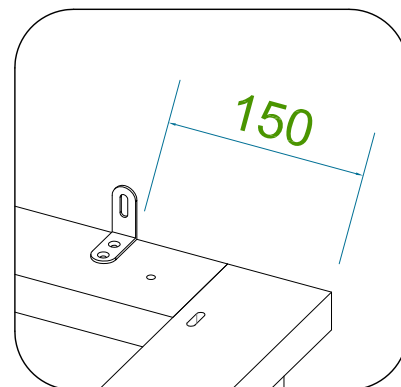
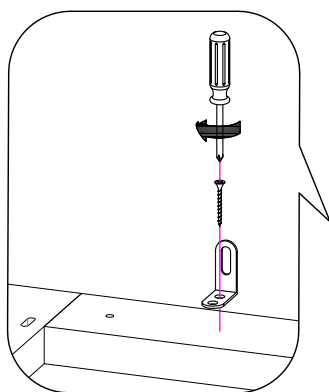
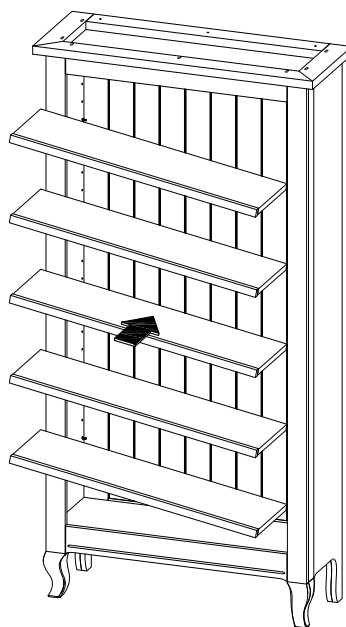
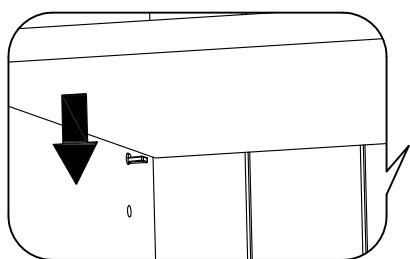

GUIDE DE FIXATION MURALE / WALL ANCHORING GUIDE

Pour éviter tout risque de basculement, ce meuble doit être accroché au mur à l'aide de l'accessoire de fixation murale inclus. Utiliser le type de vis et chevilles adaptées au support. Si le matériau de votre cloison n'est pas répertorié ou si vous avez des questions, renseignez-vous auprès d'un magasin de bricolage.

Furniture must be securely attached to the wall. The hardware used to secure your furniture to the wall depends on your wall material. If your wall material is not listed or if you have any questions, consult with a local hardware.

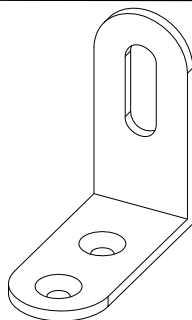

MATÉRIAU DE LA CLOISON

Cloison en plâtre avec ossature bois accessible.

DISPOSITIF DE FIXATION

Vis insérée directement dans l'ossature.

Par exemple, une vis à bois de 5 mm de notre set de chevilles et vis FIXA.

WALL MATERIAL:

Drywall or plaster with available wood stud.

ANCHORING DEVICE:

Screw inserted directly into stud.

For example, a 5mm wood screw provided with FIXA plug and screw set.

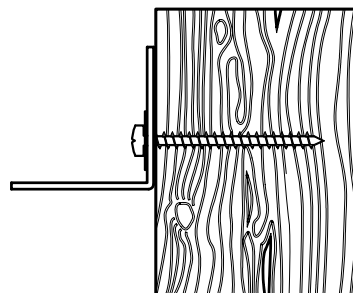

FIGURE 1

MATÉRIAU DE LA CLOISON:

Cloison en plâtre sans ossature bois accessible

DISPOSITIF DE FIXATION:

Vis avec cheville.

Par exemple, une cheville de 8 mm de notre set de vis et chevilles FIXA.

WALL MATERIAL:

Drywall without available wood stud.

ANCHORING DEVICE:

Plug with screw.

For example, an 8 mm plug provided with FIXA plug and screw set.

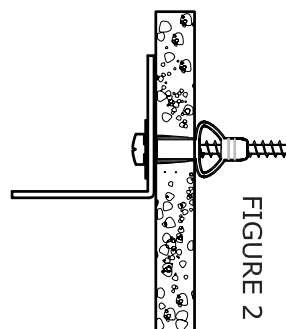

FIGURE 2

MATÉRIAU DE LA CLOISON :

Maçonnerie

DISPOSITIF DE FIXATION:

Mur plein : vis avec cheville.

Par exemple, une cheville de 8 mm de notre set de vis et chevilles FIXA. (figure 3A)

Mur creux : cheville à expansion. (figure 3B)

WALL MATERIAL:

Masonry

ANCHORING DEVICE:

Solid wall : Plug with screw.

For example, an 8 mm plug provided with FIXA plug and screw set. (figure 3A)

Hollow wall : Toggle - style (figure 3B)

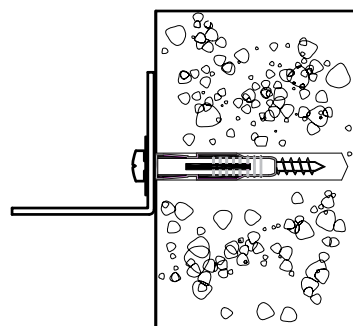

FIGURE 3A

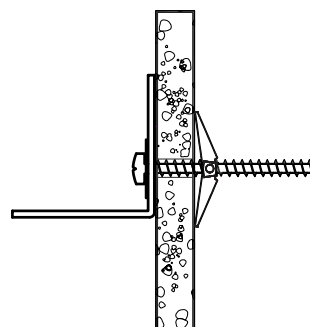

FIGURE 3B